



## Digital momenttestare med extern givare

### Tekniska data

- Brett mätområde (0.5% ~100% kapacitet) och hög noggrannhet ( $\pm 0.3\%$ )
- Analog/digital mätskala för avläsning CV/CCV
- Enheter: N·m, N·cm, kgf·cm, lbf·ft, lbf·in
- Skärmläge: Digital/Diagram
- Mätläge: Track, Peak, First Peak, Preset
- Enkel att ansluta till PC
- Utskrift: Mini Printer(data /diagram)

Modeller	N .m		N.cm		Kgf.cm		lbf.ft		lbf.in		Gränssnitt
	Kapacitet	Upplösn.	Kapacitet	Upplösn.	Kapacitet	Upplösn.	Kapacitet	Upplösn.	Kapacitet	Upplösn.	
ETTC50	0.25~50	0.005	25~5000	0.5	2.5~ 500	0.05	0.18~36.8	0.005	2.2~443	0.05	□ 1/2"(12.5)
ETTC100	0.5~100	0.01	50~10000	1	5~1000	0.1	0.37~74	0.01	4.4~885	0.1	
ETTC200	1~200	0.02			10~ 2000	0.2	0.74~147	0.02	8.9~1770	0.2	□ 1/2"(12.7)
ETTC500	2.5~500	0.05			25~ 5000	0.5	1.84~368	0.05	22~ 4425	0.5	
ETTC800	4~800	0.1			40~8000	1	2.95~590	0.1	35~7080	1	□ 3/4"(19)

Specifikationer	
Mätområde	0.5%~100% kapacitet
Noggrannhet	$\pm 0.3\%$
Enheter	N·m, N·cm, kgf·cm, lbf·ft, lbf·in
Skärm	240*160 matrix LCD med bakgrundsljus
Överbelastning	120% F.S.
Skärmläge	Data/Diagram
Mätläge	Track, Peak, AutoPeaak, FirstPeak, Preset
Provtagningsläge	1000 Hz
Minne	Upp till 1000 lagrade värden
Output	USB, Set point output, RS232C
Strömförsörjning	3.6VDC Ni-MH uppladdningsbara batterier
Laddare/Adapter	Universal USB laddare, Input:110~240VAC
Storlek	197*183*83 mm
Vikt	1.6 kg(Displayenheten)

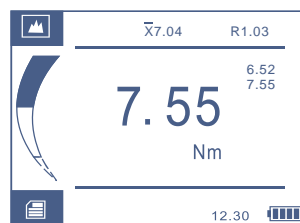

Digital Display

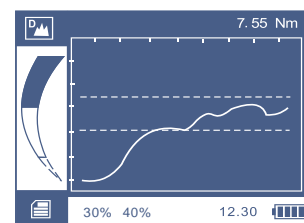
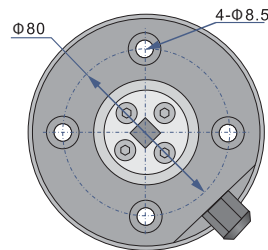
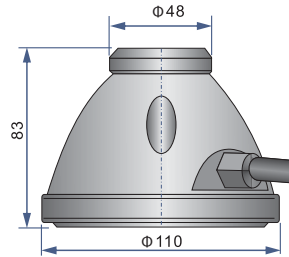
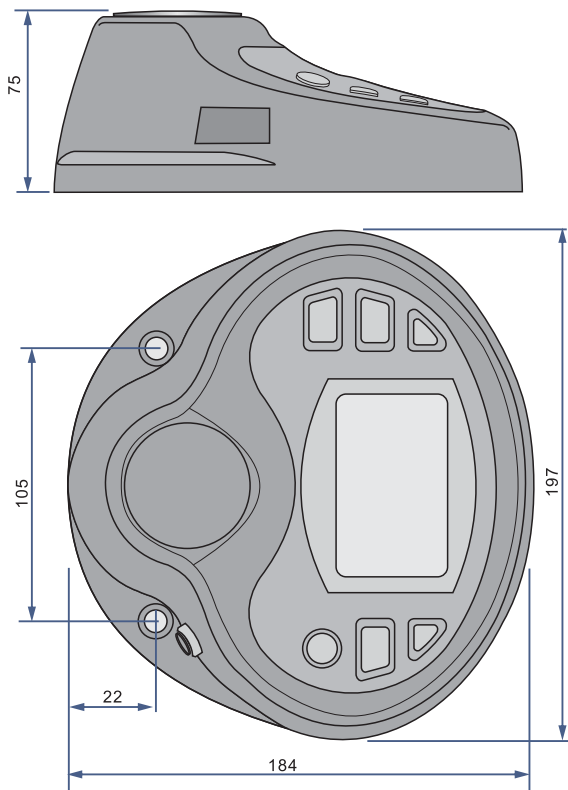

Diagram Display







## Dimensioner

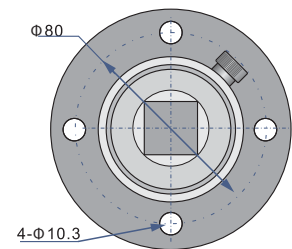
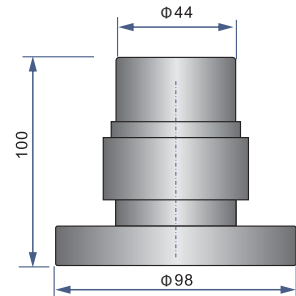

ETTC50  
ETTC100



ETTC200  
ETTC500  
ETTC800

Tillbehör	Miniprinter	Rs232 kabel	Adapter	Textfixturer	
	EPX58P	ECB-MD8-DB9	EATR	EST-TT1	EST-TT2
					

Momenttestaren levereras komplett inklusive USB-kabel för laddning/dataöverföring.

